

Wariant LEWY  
Variant L

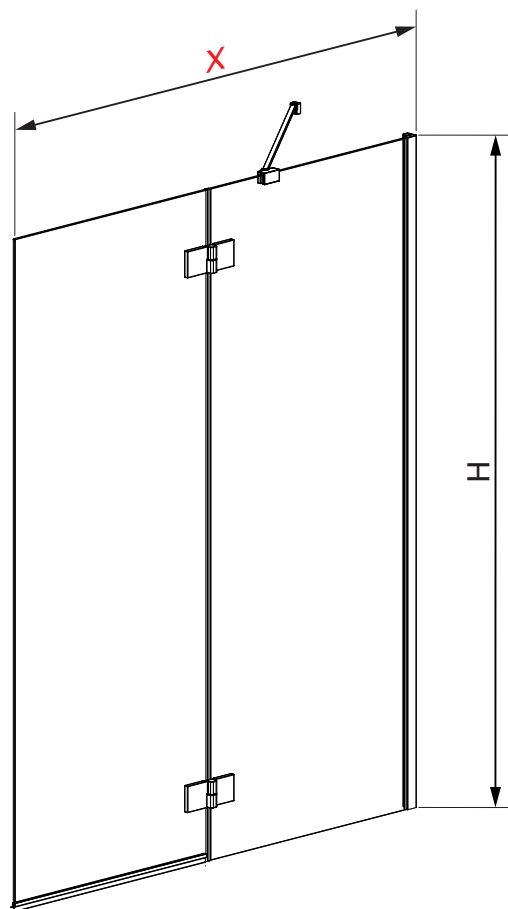

Wariant PRAWY  
Variant R

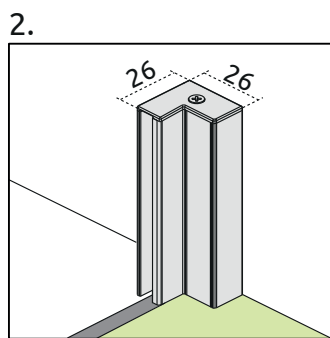
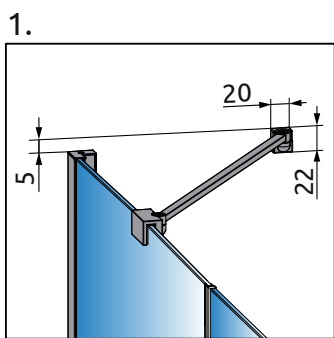

Model	X	B	C	H
PND II 100	1000-1015	486	535-550	1500
PND II 110	1100-1115	536	585-600	1500
PND II 120	1200-1215	586	635-650	1500
PND II 130	1300-1315	636	685-700	1500
PND II 140	1400-1415	686	735-750	1500

